



PowerRider™ 360°



OWNER'S MANUAL

Read and understand this entire manual before allowing child to use this product! For assistance contact Razor. DO NOT RETURN TO STORE.

NOTE: Manual illustrations are for demonstration purposes only. Illustrations may not reflect exact appearance of actual product. Specifications subject to change without notice.

Please have your 19 character product I.D. code ready before contacting Razor for warranty assistance and/or replacement parts.

Product I.D. Code: _____ - _____ - _____

CONTENTS

Safety Warnings	1-2	Repair and Maintenance.....	8-11
Before You Begin.....	3	Troubleshooting Guide	12
Assembly and Set-Up.....	4-6	PowerRider 360 Parts.....	13
Charging Battery/Pre-ride Checklist	7	Warranty	15
Usage	8		

SAFETY WARNINGS

This manual contains many warnings and cautions concerning the consequences of failing to maintain, inspect or properly use your PowerRider™ 360. Because any incident can result in serious injury or even death, we do not repeat the warning of potential serious injury or death each time such a possibility is mentioned.

⚠ WARNING: Riding an electric PowerRider 360 does present potential risks and caution is required. Like any riding product, an electric PowerRider 360 has inherent hazards associated with its use (for example, falling off or riding it into a hazardous situation). Like any riding product, electric PowerRider 360s can and are intended to move and it is therefore, of course, possible to lose control or otherwise get into dangerous situations. Both children and adults responsible for supervising them must recognize that if such things occur, a rider can be seriously injured or die, even when using safety equipment and other precautions. Certain conditions may cause the equipment to fail without fault of the manufacturer. **RIDE AT YOUR OWN RISK AND USE COMMON SENSE.**

This manual contains important safety information. It is your responsibility to review this information and make sure that all riders understand all warnings, cautions, instructions and safety topics, and assure that young riders are able to safely and responsibly use this product. Razor recommends that you periodically review and reinforce the information in this manual with younger riders, and that you inspect and maintain your child's PowerRider 360° to insure their safety.

⚠ WARNING: PARENTAL AND ADULT RESPONSIBILITY AND SUPERVISION IS NECESSARY: Because products, like electric PowerRider 360s, can and do present potential hazards plainly associated with their use, it is well recognized THE NEED FOR EXERCISE OF PARENTAL RESPONSIBILITY IN SELECTING RIDING PRODUCTS APPROPRIATE TO THE AGE OF A CHILD, OR PARENTAL SUPERVISION IN SITUATIONS IN WHICH CHILDREN OF VARIOUS AGES MAY HAVE ACCESS TO THE SAME RIDING PRODUCTS, IS IMPORTANT. Not every product is appropriate for every age or size of child, and different age recommendations are found within this category of product which are intended to reflect the nature of the hazards and the expected mental or physical ability, or both, of a child to cope with the hazards.

The recommended rider age is 8 and older. Any rider unable to fit comfortably on the PowerRider 360 should not attempt to ride it. A parent's decision to allow his or her child to ride this product should be based on the child's maturity, skill and ability to follow rules.

Keep this product away from small children and remember that it is intended for use only by persons who are, at a minimum, completely comfortable and competent while operating the PowerRider 360.

Persons with any mental or physical conditions that may make them susceptible to injury, impair their physical dexterity or mental capabilities to recognize, understand, and follow safety instructions and to be able to understand the hazards inherent in PowerRider 360 use, should not use or be permitted to use products inappropriate for their abilities. Persons with heart conditions, head, back or neck ailments (or prior surgeries to these areas of the body), or pregnant women, should be cautioned not to operate such products.

DO NOT EXCEED THE WEIGHT LIMIT OF 120 lb (54 kg). Rider weight does not necessarily mean a person's size is appropriate to fit or maintain control of the PowerRider 360.

CHECK AND MAINTAIN POWERRIDER 360 CONDITIONS

Before use, check to confirm that any and all chain guards or other covers and guards are in place and in serviceable condition. Check that the brake is functioning properly, and that the tire is inflated properly and have sufficient tread remaining. The PowerRider 360 should be maintained and repaired in accordance with the manufacturer's specifications, using only the manufacturer's authorized replacement parts, and should not be modified from the manufacturer's original design and configuration.

ACCEPTABLE RIDING PRACTICES AND CONDITIONS

Always check and obey any local laws or regulations which may affect the locations where the electric PowerRider 360 may be used. Keep safely away from cars and motor vehicle traffic at all times, and only use where allowed and with caution.

Do not activate the speed control on the hand grip unless you are on the PowerRider 360 and in a safe, outdoor environment, suitable for seated riding.

The normal powered top speed of this PowerRider 360 will be approximately 9 mph (14 kmh), which can be affected by conditions, such as rider weight, inclines, tire inflation and battery charge level. Avoid excessive speeds that can be associated with downhill rides.

Maintain a hold on the handlebars at all times. Do not touch the brakes or motor on your PowerRider 360 when in use or immediately after riding as these parts can become very hot.

Ride defensively. Watch out for potential obstacles that could catch your wheel or force you to swerve suddenly or lose control. Be careful to avoid pedestrians, skaters, skateboards, PowerRider 360s, bikes, children or animals who may enter your path, and respect the rights and property of others.

The electric PowerRider 360 is intended for use on flat, dry surfaces, such as pavement or level ground, without loose debris, such as sand, leaves, rocks or gravel. Wet, slick, bumpy, uneven or rough surfaces may impair traction and contribute to possible accidents. Do not ride your PowerRider 360 in mud, ice, puddles or water. Avoid sharp bumps, drainage grates, and sudden surface changes.

Do not attempt or do stunts or tricks on your electric PowerRider 360. The PowerRider 360 is not made to withstand abuse from misuse, such as jumping, curb grinding or any other type of stunts. Racing, stunt riding, or other maneuvers also enhance risk of loss of control, or may cause uncontrolled rider actions or reactions.

Never allow more than one person at a time to ride the PowerRider 360.

Do not ride at night or when visibility is limited.

Never use near steps or swimming pools.

Do not allow hands, feet, hair, body parts, clothing, or similar articles to come in contact with moving parts, wheels, or drivetrain, chain while the motor is running.

SAFETY WARNINGS

Never use headphones or a cell phone when riding.

Never hitch a ride with a vehicle.

Do not ride your PowerRider™ 360 in wet or icy weather and never immerse the PowerRider 360 in water, as the electrical and drive components could be damaged by water or create other possibly unsafe conditions. Never risk damaging surfaces, such as carpet or flooring, by use of an electric PowerRider 360 indoors.

PROPER RIDING ATTIRE

Riders should always wear a properly fitted helmet that complies with U.S. Consumer Safety Commission (CPSC) Standard 16 CFR 1203. A helmet may be legally required by local law or regulation in your area. A long-sleeved shirt, long pants, and gloves are recommended. Always wear athletic shoes (lace-up shoes with rubber soles), never ride barefooted or in sandals, and keep shoelaces tied and out of the way of the wheels, motor and drive system.

USING THE CHARGER

The charger supplied with the electric PowerRider 360 should be regularly examined for damage to the cord, plug, enclosure and other parts. In the event of such damage, the PowerRider 360 must not be charged until the charger has been repaired or replaced.

Use only with the recommended charger.

Use caution when charging.

The charger is not a toy. Charger should be operated by an adult.

Do not operate charger near flammable materials.

Unplug charger and disconnect from PowerRider 360 when not in use.

Always disconnect from the charger prior to wiping down and cleaning your PowerRider 360 with damp cloth.

**FAILURE TO USE COMMON SENSE AND HEED THE ABOVE WARNINGS INCREASES RISK OF SERIOUS INJURY.
USE WITH APPROPRIATE CAUTION AND SERIOUS ATTENTION TO SAFE OPERATION.**

BEFORE YOU BEGIN

Remove contents from box and check parts against parts diagram found on page 13. Remove the separators that protect the components from damage during shipping. Inspect the contents of the box for scratches in the paint or dents that may have occurred during shipping. Because the PowerRider™ 360° was partially assembled and packed at the factory there should not be any problems, even if the box has a few scars or dents.

□ Estimated Assembly and Set-Up Time

Allow up to 15–20 minutes for assembly.

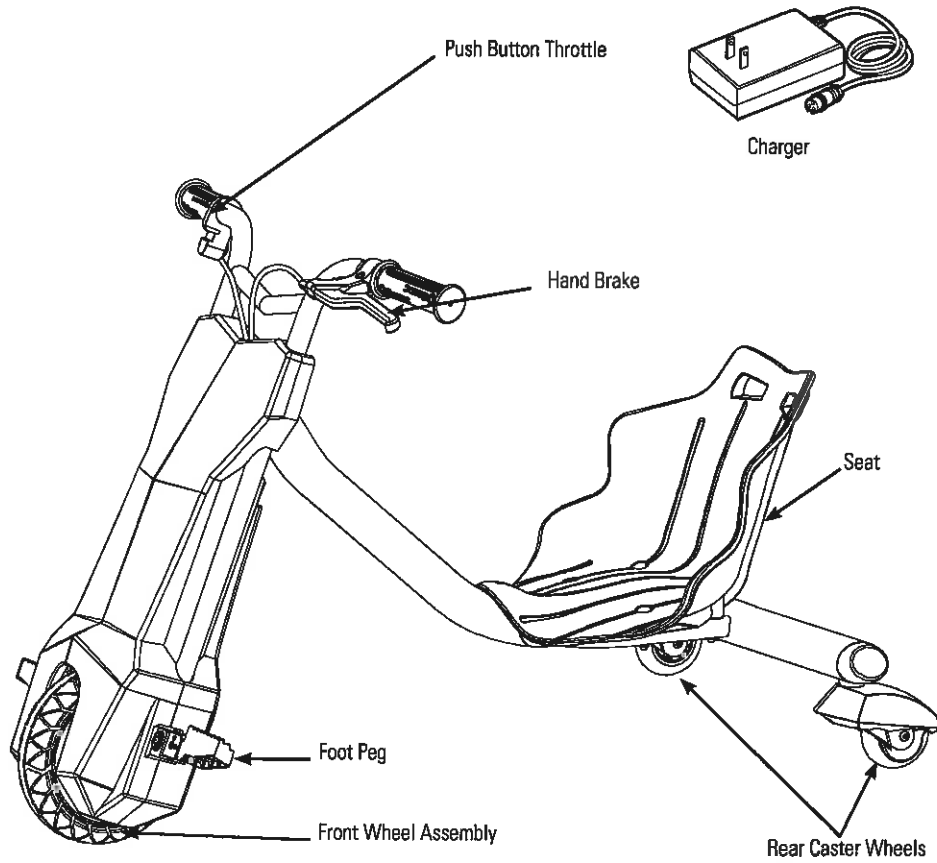

⚠ WARNING: DO NOT USE NON-RAZOR PRODUCTS WITH YOUR POWERRIDER 360°.

The PowerRider 360° has been built to certain Razor design specifications. The original equipment supplied at the time of sale was selected on the basis of its compatibility with the frame, fork and all other parts. Certain aftermarket products may not be compatible and will void your warranty.

PRODUCT I.D. CODE

1. Undemeath Frame
2. Charger
3. UPC Side of Box (not shown)

□ Required Tools

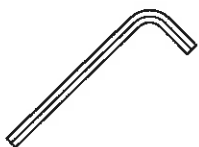

5 mm Allen wrench
(Included)



8 mm/10 mm/14 mm/17 mm
wrenches
(Not included)



Phillips screwdriver
(Not Included)

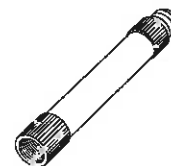

Valve Extender
(Located in the right
handlebar grip)

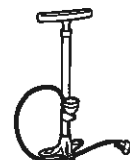

Bicycle tire pump for
Schrader valves, with
pressure gauge
(Not Included)

Need Help? Visit our web site for replacement parts and product support at www.razor.com or call toll-free at 866-467-2967 Monday - Friday 8:00 AM - 5:00 PM Pacific Time. Please have the product I.D. code (located on the white label on your product or back of charger) available for better assistance.

ASSEMBLY AND SET-UP

□ Attaching the Frame

Required Tools: Two (2) 5 mm Allen wrenches

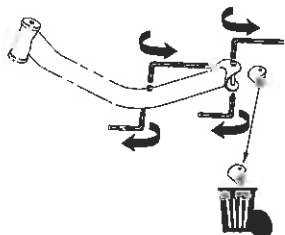

1 Using two (2) 5 mm Allen wrenches, remove the coupling bolt on the end of the frame and discard the plastic insert. Remove the coupling bolt in the middle of the frame.

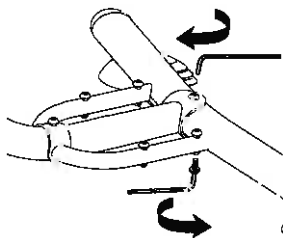

2 Insert the rear frame into the frame assembly. Securely tighten the (long) coupling bolt on the rear frame using two (2) 5 mm Allen wrenches.

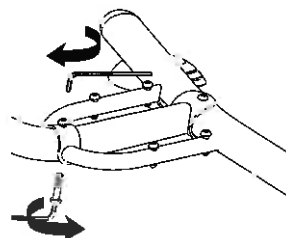

3 Securely tighten the (short) coupling bolt in the middle of the frame using two (2) 5 mm Allen wrenches.

Note: The coupling bolts on the frame are different lengths.

□ Attaching the Front Fork

Required Tools: 5 mm Allen wrench

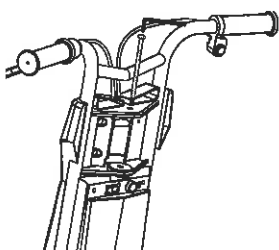

1 Using a 5 mm Allen wrench, remove the steering bolt from the frame assembly.

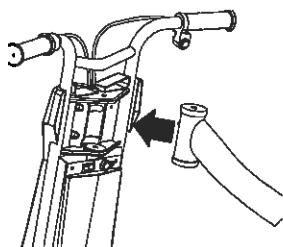

2 Insert the front fork into the frame assembly.

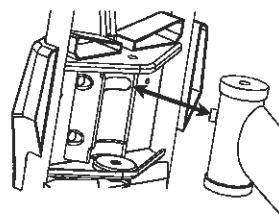

3 Be sure to properly align the slot on headtube with the pin on the front fork as shown.

⚠ WARNING: Failing to properly tighten the steering bolt that attaches the front fork assembly to the frame assembly can cause you to lose control and fall.

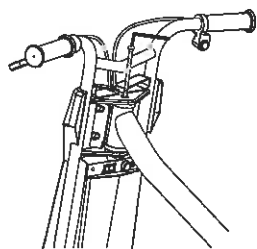

4 Reinsert the steering bolt and secure using a 5 mm Allen wrench.

ASSEMBLY AND SET-UP

Attaching the Seat

Required Tools: Two (2) 5 mm Allen wrenches

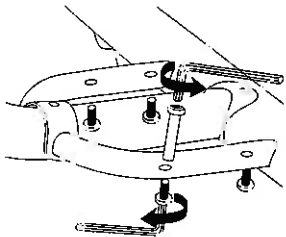

1 Using two (2) 5 mm Allen wrenches, remove the four (4) coupling bolts from the rear frame.

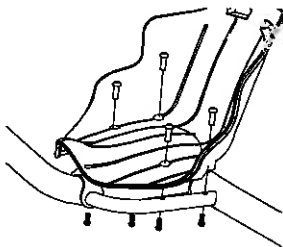

2 Align the four (4) holes in seat with the four (4) holes in frame. Insert the coupling bolts through the top and bottom of the frame.

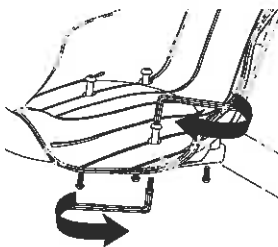

3 Tighten the coupling bolts using two (2) 5 mm Allen wrenches.

Inflating the Front Tire

The tire is inflated when shipped, but it invariably loses some pressure between the point of manufacturing and your purchase. **Always inflate tire to the correct PSI before first time use.**

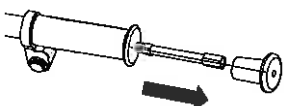

1 Remove valve extender from right handlebar grip.

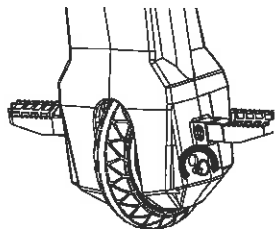

2 Open the round cover located on the chain cover by sliding the cover upward.

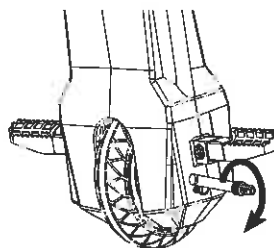

3 Align the opening in the drive sprocket with the valve stem. Thread the valve extender completely onto the valve stem.

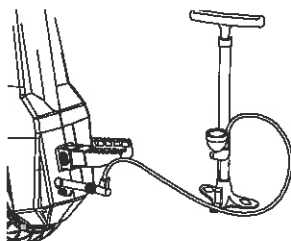

4 Attach the pump and inflate to 36 PSI.

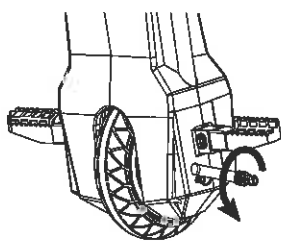

5 Remove valve extender immediately after inflating.

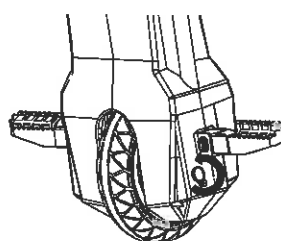

6 Close the cover by sliding the cover downward.

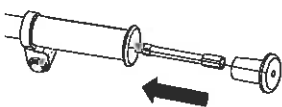

7 Place the valve extender back into the right handlebar grip.

WARNING:

Failure to remove the valve extender after inflating will cause the inner tube and/or adapter to be severed by the front drive sprocket.

Note: If you lose the valve extender, contact customer service, or one can be purchased at almost any auto parts store.

WARNING:

Do not over inflate as this could damage tire or wheel

Note: The pressurized air supplies found at gasoline stations are designed to inflate high-volume automobile tires. If you decide to use such an air supply to inflate your PowerRider 360 tire, first make sure the pressure gauge is working, then use very short bursts to inflate to the correct PSI. If you inadvertently over-inflate the tire, release the excess pressure immediately.

ASSEMBLY AND SET-UP

□ Attaching the Flag

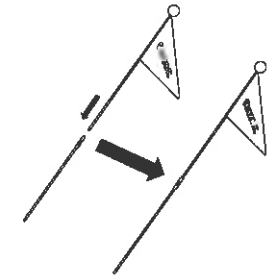

1

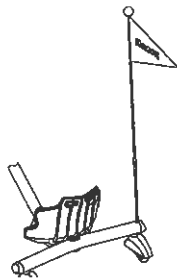

2 Insert flag into fixed hole located on the rear of the frame.

□ Unfolding the Foot Pegs

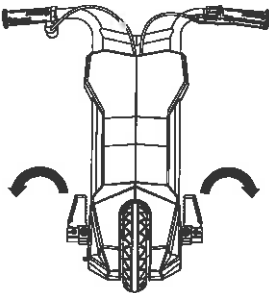

1 Unfold the foot pegs.

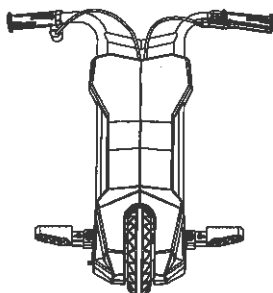

⚠ WARNING:
When riding, foot pegs must be unfolded and both feet placed securely on pegs.

Need Help? Visit our web site for replacement parts and product support at www.razor.com or call toll-free at 866-467-2967 Monday - Friday 8:00 AM - 5:00 PM Pacific Time. Please have the product I.D. code (located on the white label on your product or back of charger) available for better assistance.

CHARGING THE BATTERY

❑ Charging the Battery

Your PowerRider 360 may not have a fully charged battery; therefore it is a good idea to charge the battery prior to use.

- Initial charge time: 12 hours.
- Recharge time: up to 12 hours, even if the light turns green. Recommended maximum charging time is 24 hours.
- Always charge the battery immediately after riding.
- Fully charge battery before storing for extended periods of time.
- Unplug charger from the wall outlet when not in use.
- Failure to recharge battery periodically may result in a battery that will not accept a charge.
- Make sure power switch is turned OFF when unit is not in use. If the power switch is left on for an extended period of time, the battery may reach a stage at which it will no longer hold a charge.
- To ensure long battery life, never store the product in freezing or below freezing temperatures! Freezing will permanently damage the battery.
- Run time: Up to 30 minutes of continuous ride time. Run time may vary depending on riding conditions, rider weight, climate and/or proper maintenance.
- Constant stopping and starting may shorten ride time.
- Average battery life for a properly maintained unit is approximately 250 charge/discharge cycles.

Charger

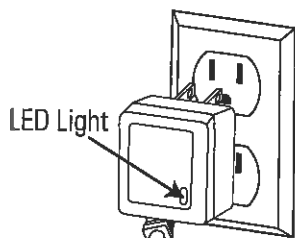
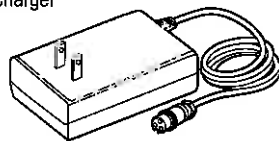

1 Plug the charger into wall outlet. The light on the charger should be green.

Note: If green light (LED) does not turn on, try a different outlet

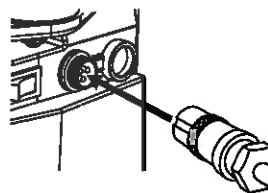

2 Make sure the power switch is in the "OFF" position. Plug the charger into the charger port on the product. The light on the charger should turn red during charging. The light will turn green when charging is complete.

Note: Make sure power is turned OFF when unit is not in use. If the power switch is left on for an extended period of time, the battery may reach a stage at which it will no longer hold a charge.

Note: Charger may look different than the pictures above.

⚠ WARNING: Use ONLY with the recommended charger. Batteries are only to be charged under adult supervision. The charger is not a toy. Always disconnect the charger before wiping down and/or cleaning the PowerRider 360 with a damp cloth.

The charger supplied with the PowerRider 360 should be regularly examined for damage to the cord, plug, enclosure and other parts. In the event of such damage, the PowerRider 360 must not be charged until it has been repaired or replaced.

Chargers have built-in over-charge protection to prevent battery from being over-charged.

Charger may get warm during use. This is normal for some chargers and is no cause for concern. If your charger does not get warm during use, it does not mean that it is not working properly.

Wall outlet - Green
Wall outlet and Unit (Charging) - Red
Charging complete - Green

Note: Continue charging unit even if light turns green prior to 12 hours.

⚠ WARNING: Battery charge can deplete over time. Periodically recharge battery when not in use.

PRE-RIDE CHECKLIST



Loose Parts

Check and secure all fasteners before every ride. There should not be any unusual rattles or sounds from loose parts or broken components. If you are not sure, contact customer service.



Wheels

Practice drift riding only in wide open areas clear from curbs, parking blocks and other obstacles. Impacting the wheels against any hard surface can damage the wheels. Wheels are not covered under your limited warranty.



Frame, Fork and Steering Wheel

Check for cracks or broken connections. Although broken frames are rare, it is possible for an aggressive rider to run into a curb or wall and wreck, bend or break a frame. Get in the habit of inspecting the PowerRider 360 before every ride.



Safety Gear

Always wear proper protective equipment, such as an approved safety helmet. Elbow pads and kneepads are recommended. Always wear shoes (lace-up shoes with rubber soles), never ride barefooted or in sandals, and keep shoelaces tied and out of the way of the wheels, motor, and drive system.

USAGE

□ Starting the PowerRider 360

To start the unit, turn the power switch "ON". Place both hands on the handlebars and press the push button throttle.

Note: Keep both feet on the foot pegs when unit is in motion.

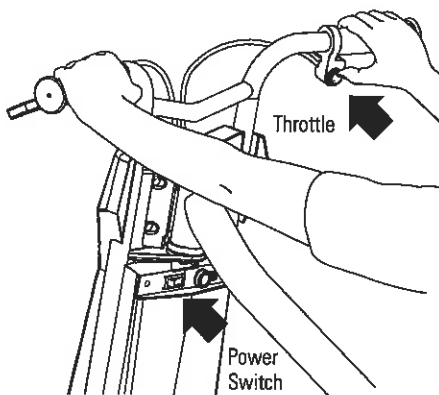

□ Stopping the PowerRider 360

To stop the unit, release the push button throttle and apply the brake until the unit comes to a complete stop.

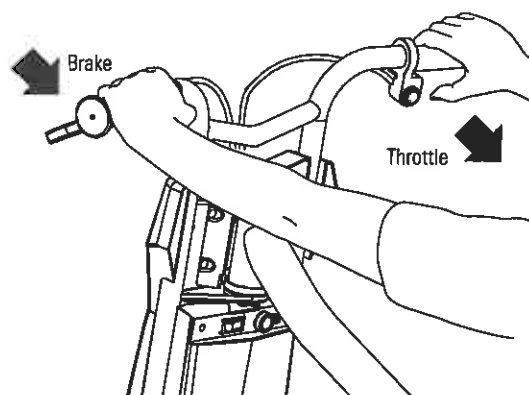

REPAIR AND MAINTENANCE

Turn power switch "OFF" before conducting any maintenance procedures.

□ Chain and Front Tire Replacement

Required Tools: Phillips screwdriver, 10 mm wrench, two (2) 8 mm wrenches, 14 mm wrench and 17 mm wrench

Disassembly

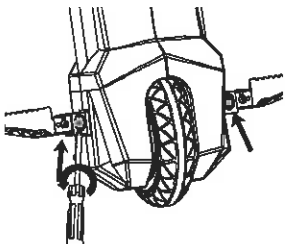

1 Using a Phillips screwdriver, loosen the two (2) screws located on each side of the motor cover/chain guard.

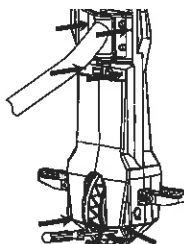

2 Using a Phillips screwdriver, loosen the six (6) screws to remove the motor cover/chain guard.

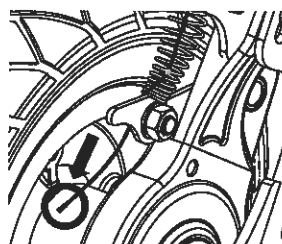

3 Remove the cable cap at the end of the cable. (Do not lose.)

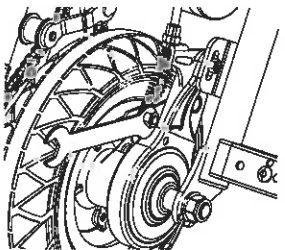

4 Using a 10 mm wrench, loosen the brake cable anchor bolt and disconnect the cable.

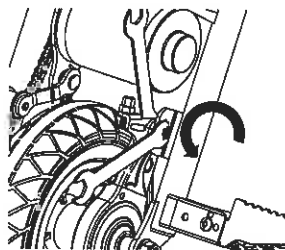

5 Using two (2) 8 mm wrenches, remove the brake housing anchor from the fork and brake plate. Keep the bolt, washer and nuts together.

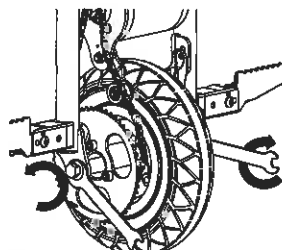

6 Using 14 mm and 17 mm wrenches, loosen the axle locknuts. Push down and remove the wheel from the fork. Remove the chain from the front sprocket.

Need Help? Visit our web site for replacement parts and product support at www.razor.com or call toll-free at 866-467-2967 Monday - Friday 8:00 AM - 5:00 PM Pacific Time. Please have the product I.D. code (located on the white label on your product or back of charger) available for better assistance.

REPAIR AND MAINTENANCE

Reassembly

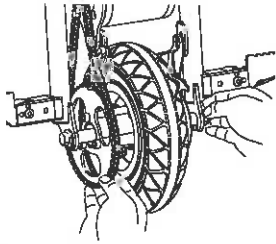

1 Install the chain onto the front wheel sprocket. Slip the wheel axle into the fork slot and through the wheel (note the sequence of the hardware pictured to the right). Push the chain tensioner down to create slack in the chain. Hand tightened the front axle locknuts.

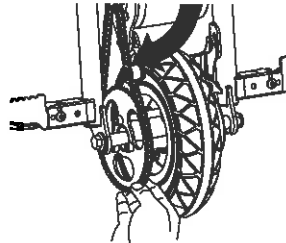

2 Verify the chain is properly installed on each sprocket and that the tensioner is correctly positioned at the bottom of the chain.

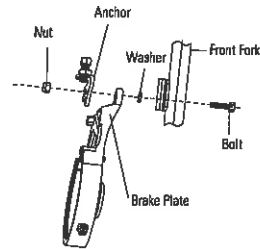

3 Install the brake housing anchor on the front and brake plate using the bolt, washer and nut. Do not tighten.

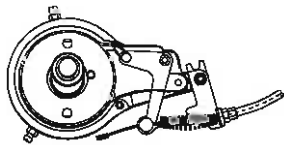

4 Thread the brake cable through the brake adjuster barrel, through the large spring and into the small hole in the side of the anchor bolt. Position the cable in the original location (as indicated by the slight kink in the cable) and tighten securely. Reattach the cable cap to the end of the cable

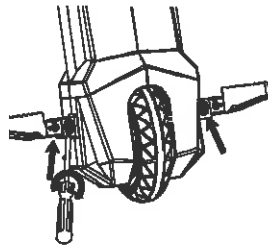

5 Replace the motor cover/chain guard. Refer to steps 1 and 2.

Note: Front wheel hardware sequence

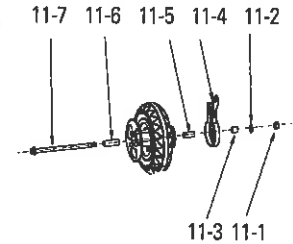

Right Side (Throttle)

11-7 Axle Bolt

Fork

11-6 Spacer (long)

Left Side (Brake)

11-1 Locknut

11-2 Washer

Fork

11-3 Spacer (short)

11-4 Brake Plate

11-5 Spacer (short)

REPAIR AND MAINTENANCE

□ Adjusting the Brake

Required Tools: Phillips screwdriver, 10 mm wrench

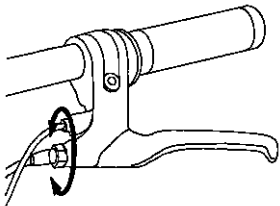

1 To adjust the brake cable tension, thread the brake lever adjuster in or out 1/4 to 1/2 turn until the desired brake adjustment is attained. Most adjustments are complete at this step. If the brake still needs further adjustment, proceed to the following steps.

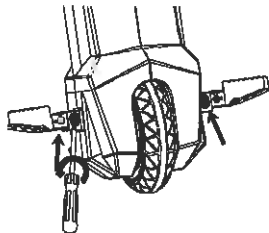

2 Using a Phillips screwdriver, loosen the two (2) screws on the foot pegs.

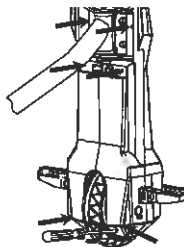

3 Using a Phillips screwdriver, loosen the six (6) screws to remove the motor cover/chain guard.

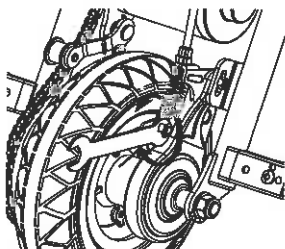

4 If the brake is too tight or too loose, use a 10 mm wrench to loosen the nut on the brake cable for additional adjustment. Securely tighten the nut when finished.

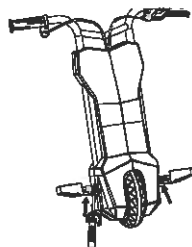

5 Replace the motor cover/chain guard. Refer to steps 2 and 3 above.

Need Help? Visit our web site for replacement parts and product support at www.razor.com or call toll-free at 866-467-2967 Monday - Friday 8:00 AM - 5:00 PM Pacific Time. Please have the product I.D. code (located on the white label on your product or back of charger) available for better assistance.

REPAIR AND MAINTENANCE

Battery Care and Disposal

Do not store in freezing or below freezing temperatures. To properly maintain your battery and ensure maximum battery life, carefully read the "Charging the Battery" section on page 6 of this owner's manual.



CONTAINS SEALED LEAD ACID BATTERIES. BATTERIES MUST BE RECYCLED.

Disposal: Your Razor product uses sealed lead-acid batteries which must be recycled or disposed of in an environmentally safe manner. Do not dispose of a lead-acid battery in a fire. The battery may explode or leak. Do not dispose of a lead-acid battery in your regular household trash. The incineration, land filling or mixing of sealed lead-acid batteries with household trash is prohibited by law in most areas. Return exhausted batteries to a federal or state approved lead-acid battery recycler or a local seller of automotive batteries. If you live in Florida or Minnesota, it is prohibited by law to throw away lead-acid batteries in the municipal waste stream.

Charger

The charger supplied with the PowerRider 360 should be regularly examined for damage to the cord, plug, enclosure and other parts, and in the event of such damage, the product must not be charged until it has been repaired or replaced.

Use ONLY with the recommended charger.

Wheels

Wheels and drive system are subject to normal wear and tear. It is the responsibility of the user to periodically inspect wheels for excess wear and adjust and replace drive train components as required.

Replacement Parts

For the complete selection of replacement parts visit www.razor.com.

Service Centers

For a list of authorized Razor repair centers:

- Check online at www.razor.com.
- Call 866-467-2967 for the center nearest you.

⚠ WARNING: If a battery leak develops, avoid contact with the leaking acid and place the damaged battery in a plastic bag. Refer to the disposal instructions at left. If acid comes into contact with skin or eyes, flush with cool water for at least 15 minutes and contact a physician.

⚠ WARNING: Battery posts, terminals and related accessories contain lead and lead compounds. Wash your hands after handling.

TROUBLESHOOTING GUIDE

Problem	Possible Cause	Solution
Product does not run.	Undercharged battery.	Charge the battery. A new battery should have been charged for at least 12 hours before using the product for the first time and up to 12 hours after each subsequent use. Check all connectors. Make sure the charger connector is tightly plugged into the charging port and that the charger is plugged into a functioning wall outlet.
	Charger is not working.	Contact Razor Customer Service to get replacement charger.
Product was running but suddenly stopped.	Loose wires or connectors.	Check all wires and connectors to make sure they are tight.
Short run time.	Undercharged battery.	Charge the battery. A new battery should have been charged for at least 12 hours before using the product for the first time and up to 12 hours after each subsequent use.
	Battery is old and will not accept full charge.	Even with proper care, a rechargeable battery does not last forever. Average battery life is 1 to 2 years depending on product use and conditions. Replace only with a Razor replacement battery.
Product runs sluggishly.	Riding conditions are too stressful.	Use only on solid, flat, clean and dry surfaces, such as pavement or level ground.
	Product is overloaded.	Make sure you do not overload the product by allowing more than one rider at one time, exceeding the maximum weight limit, going up too steep a hill, or towing objects behind the product. Check the air pressure of the front wheel.
Sometimes the product doesn't run, but other times it does.	Loose wires or connectors.	Check all wires connectors to make sure they are tight.
	Motor or electrical switch damage.	Contact your local Razor authorized service center for diagnosis and repair. Contact Razor customer service or visit www.razor.com .
Product makes loud noises or grinding sounds.	Chain is too dry.	Apply a lubricant, such as 3 in 1™ or Tri-Flow™, to the chain.

Need Help? Visit our web site for replacement parts and product support at www.razor.com or call toll-free at 866-467-2967 Monday - Friday 8:00 AM - 5:00 PM Pacific Time. Please have the product I.D. code (located on the white label on your product or back of charger) available for better assistance.

POWERRIDER 360 PARTS

Keep your Pocket Mod running for years with genuine Razor parts. Visit our web site or e-mail us for more information on spare part availability. (Specifications subject to change without notice.)

- | | | |
|---------------------------------|--------------------------|-------------------------------|
| 1. Handlebar Grips (right/left) | 7. Chain Tensioner | 16. Rear Wheel Complete |
| 1-1 Handlebar Cap | 8. Control Module | 16-1 Rear Wheel Caster Cover |
| 1-2 Valve Extender | 9. Motor (12V/100W) | 16-2 Spring Washer |
| 2. Push Button Throttle | 10. Brake Lever Assembly | 16-3 Caster |
| 3. Front Fork | 11. Front Wheel Complete | 16-4 Axle Bolts |
| 4. Motor Cover/Chain Guard | 12. Foot Pegs | 16-5 Wheel |
| 5. Battery Bracket | 13. Chain | 17. Seat |
| 6. Battery (12V/5Ah) | 14. On/Off Switch | 17-1 Seat Coupling Bolts (x4) |
| | 15. Charge Port | 18. Flag |

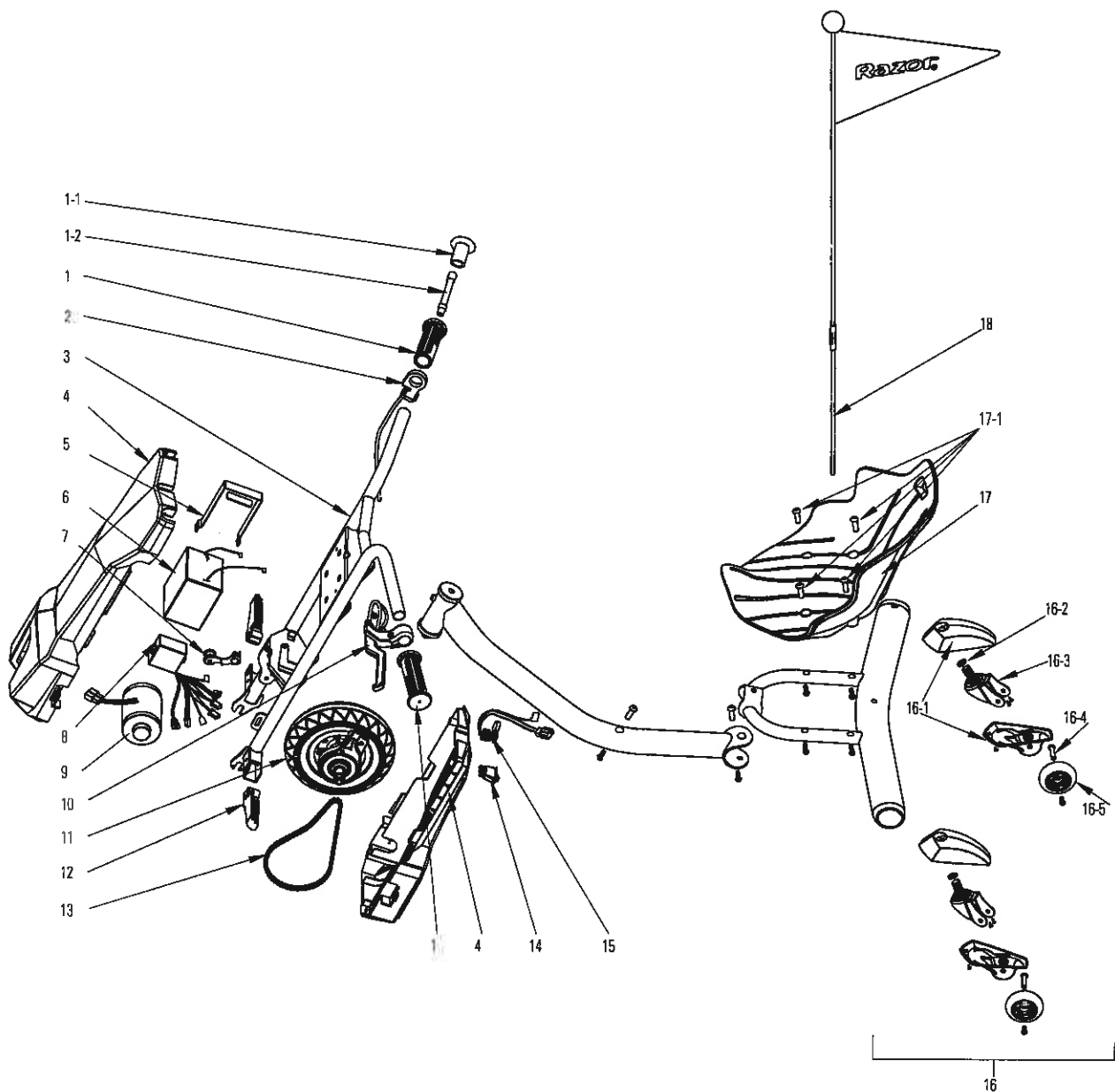

NOTICE: INSURANCE
YOUR INSURANCE POLICIES MAY NOT PROVIDE COVERAGE
FOR ACCIDENTS INVOLVING THE USE OF THIS ELECTRIC
RIDE-ON PRODUCT. TO DETERMINE IF COVERAGE IS
PROVIDED, YOU SHOULD CONTACT YOUR INSURANCE
COMPANY OR AGENT.

FCC COMPLIANCE

This device complies with Part 15 of the FCC Rules. Operation is subject to the following two conditions: (1) This device may not cause harmful interference, and (2) this device must accept any interference received, including interference that may cause undesired operation.

Note: This equipment has been tested and found to comply with the limits for a Class B digital device, pursuant to part 15 of the FCC Rules. These limits are designed to provide reasonable protection against harmful interference in a residential installation. This equipment generates, uses and can radiate radio frequency energy and, if not installed and used in accordance with the instructions, may cause harmful interference to radio communications. However, there is no guarantee that interference will not occur in a particular installation. If this equipment does cause harmful interference to radio or television reception, which can be determined by turning the equipment off and on, the user is encouraged to try to correct the interference by one or more of the following measures:

- Reorient or relocate the receiving antenna.
- Increase the separation between the equipment and receiver.
- Connect the equipment into an outlet on a circuit different from that to which the receiver is connected.
- Consult the dealer or an experienced radio/TV technician for help.

⚠ WARNING: Changes or modifications to this unit not expressly approved by Razor USA, could void the user's authority to operate the equipment.



DO NOT RETURN TO STORE

Do not use this product for the first time until you have inflated the tires to the correct PSI and charged the battery for at least 12 hours.

Failure to follow these instructions may damage your product and void your warranty.

WARRANTY

Razor Limited Warranty

The manufacturer warrants this product to be free of manufacturing defects for a period of 90 days from date of purchase. This Limited Warranty does not cover normal wear and tear, tires, tubes, cables, or any damage, failure or loss caused by improper assembly, maintenance, storage or use of the Razor PowerRider 360.

This Limited Warranty will be void if the product is ever:

- used in a manner other than for recreation;
- modified in any way;
- rented.

The manufacturer is not liable for incidental or consequential loss or damage due directly or indirectly to the use of this product.

Razor does not offer an extended warranty. If you have purchased an extended warranty, it must be honored by the store at which it was purchased.

For your records, save your original sales receipt with this manual and write the serial number below. The serial number is located on the bottom of the frame directly under the motor.

Need Help? Visit our web site for replacement parts and product support at www.razor.com or call toll-free at 866-467-2967 Monday - Friday 8:00 AM - 5:00 PM Pacific Time. Please have the product I.D. code (located on the white label on your product or back of charger) available for better assistance.

Patent Pending

Printed in China for:
Razor USA LLC
PO Box 3610
Cerritos, CA 90703

Copyright © 2003 - 2013 Razor USA LLC. All rights reserved. RAZOR and the Razor Logo Design are among the registered trademarks of Razor USA LLC in the United States and/or select foreign countries. PowerRider 360 is a trademark of Razor USA LLC.