

Power Contactor
RLY-60150

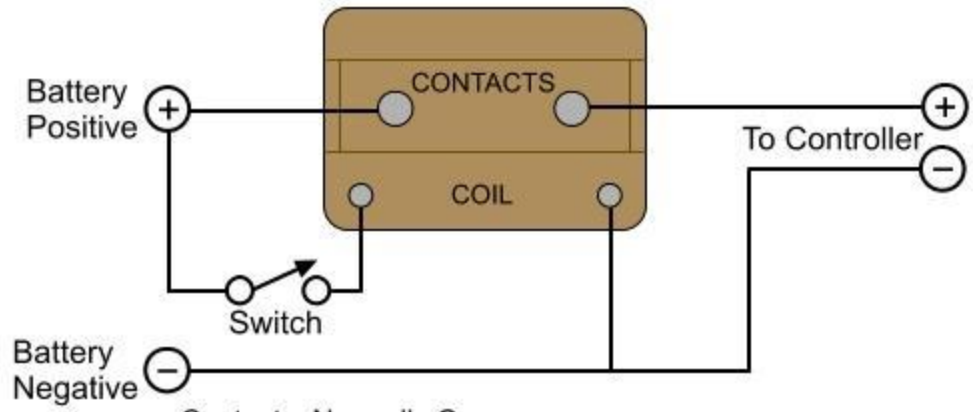

Contacts: Normally Open
Maximum Continuous Contacts Load: 150 Amps
Rated Coil Voltage: 60 Volts DC
Maximum Coil Voltage: 72 Volts DC
Coil Pull-In Voltage: 34 Volts DC
Coil Pull-Out Voltage 12 Volts DC